

LED



23 W
2.100 lm
26 W
1.550 lm
25.000 h
3.000 K
15.000 x
<0,5 s

831531

230V/50Hz~



1 x LED-Board 45V DC / 23 W

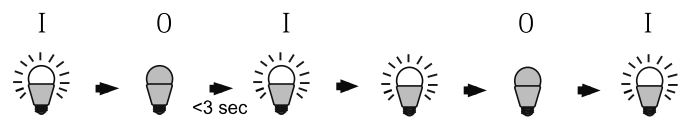
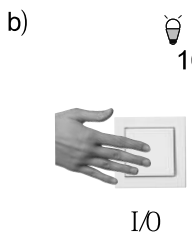
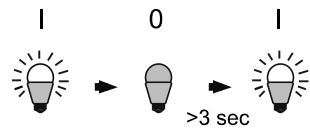
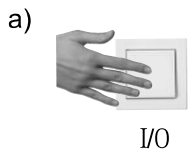
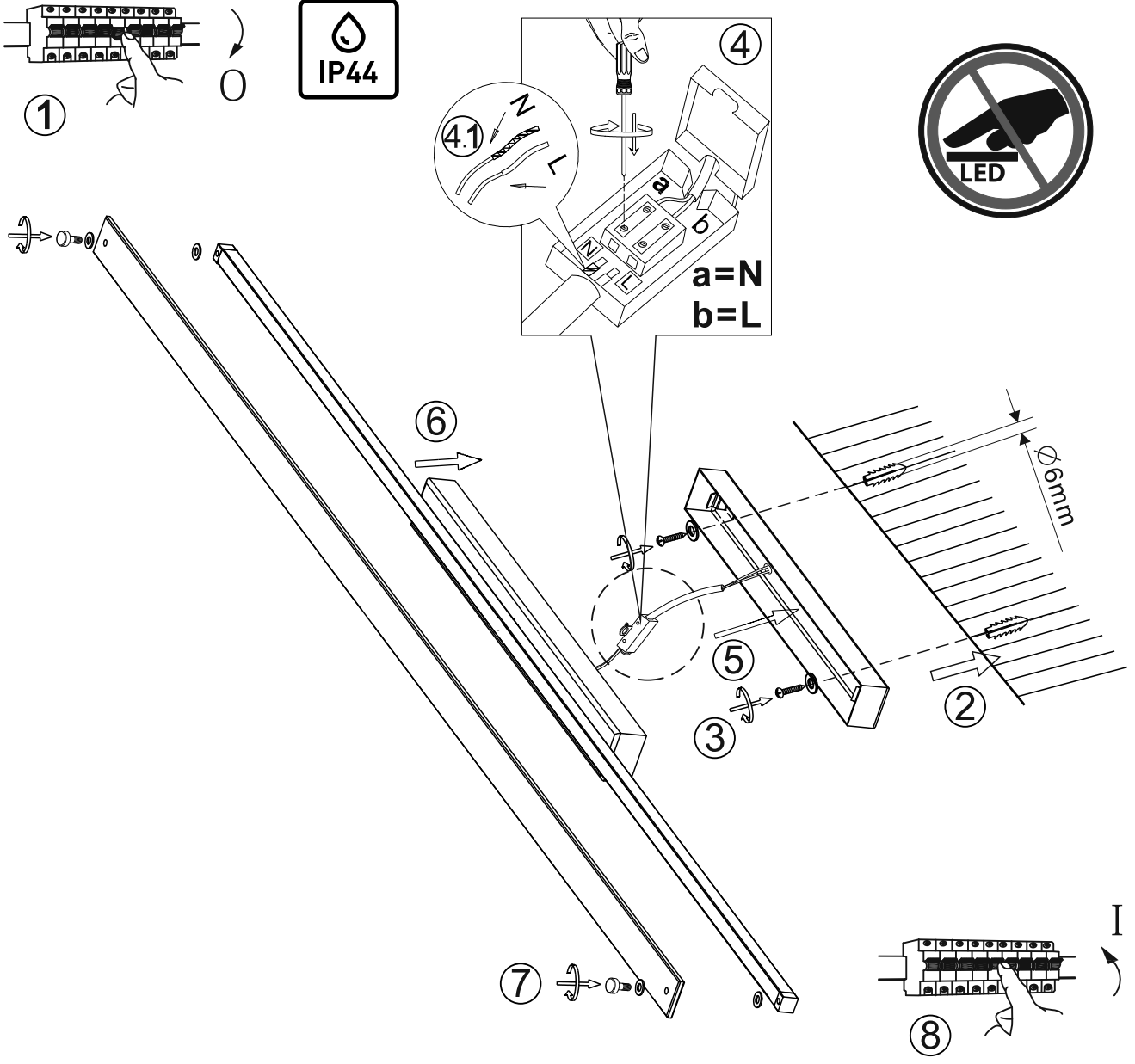





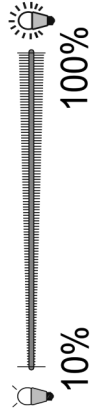

Paul Neuhaus



Paul Neuhaus GmbH
Olakenweg 36 • 59457 Werl
Germany

b)



I / 0	I	0
		
функция на регулиране на светлинния поток Funke ztlumeni Dimm-Funktion Dæmpningsfunktion Función reguladora Häänduse funktsioon Fonction variateur Himmennyksen toiminto Dimmer function Λειτουργία μετριάσεως φωτισμού Fénytempítő funkció Funkcija prigušivanja Funzione di regolazione Pritērdymo funkcija Spilgtuma samazināšanas funkcija Dimmfunksjon Dimfunctie Função de regulação de intensidade da luz Funkcja ściemniania Funcție de micșorare a lumini функция диммирования Dimmfunktion funkcija stmievania Funkcija zatemnitve funkcija zatamnjivanja Karartma fonksiyonu	Лампата започва да регулира светлинния поток Světlo se začne ztlumovat Leuchte beginnt zu dimmen Lampen begynder at aftage i styrke La lámpara comienza a regular Valgus hakkab häänduma La lumière commence à baisser Valo alkaa himmentymään light starts to dim Το φως φηχίζει να εξασθενεί A lámpa fénye tompulni kezd Svetlo se počinje prigušivati La luminosità inizia a ridursi Šviesos pritemsta Lampa sāk samazināt spilgtumu Lyset begynner å dimme Lamp begint te dimmen A lámpada começa a regular a intensidade da luz Lampa zaczyna ściemniać się Lampa începe să reducă lumina светильник плавно набирает яркость Lampan börjar att dimra svetidlo sa začne stmievať Svetilka prične zatemnjevat svetiljka počinje da zatamnjuje Aydınlatma, kararmaya başlar	Достигната желаната светлост Dosaženo požadovaného jasu gewünschte Helligkeit erreicht Nået ønsket lysstyrke se alcanza la claridad deseada Soovitud heledus on saavutatud atteint la luminosité souhaitée Haluttu kirkkaus on saavutettu desired brightness attained Επιτεύχθηκε επιθυμητή φωτεινότητα A kívánt világosság elérve Željena svjetloća je postignuta Raggiunge la luminosità desiderata Pasiektas norimas šviesumas Sasniegta nepieciešamā spilgtuma pakāpe Lyset begynner å dimme Gewenste helderheid bereikt O brilho pretendido foi atingido Požadany poziom jasności zostat osiągnięty Luminozitate dorită atinsă желаемая яркость достигнута Onskad ljusstyrka uppnådd dosiahnutý požadovaný jas dosežena želena svetlost postignuta željena osvetljenost Istenilen aydınliğa ulaşıldı

I	0	I
		
Достижната желаната светлост Dosaženo požadovaného jasu gewünschte Helligkeit erreicht Nået ønsket lysstyrke se alcanza la claridad deseada Soovitud heledus on saavutatud atteint la luminosité souhaitée Haluttu kirkkaus on saavutettu desired brightness attained Επιτεύχθηκε επιθυμητή φωτεινότητα A kívánt világosság elérve Željena svjetloća je postignuta Raggiunge la luminosità desiderata Pasiektas norimas šviesumas Sasniegta nepieciešamā spilgtuma pakāpe Lyset begynner å dimme Gewenste helderheid bereikt O brilho pretendido foi atingido Požadany poziom jasności zostat osiągnięty Luminozitate dorită atinsă желаемая яркость достигнута Onskad ljusstyrka uppnådd dosiahnutý požadovaný jas dosežena želena svetlost postignuta željena osvetljenost Istenilen aydınliğa ulaşıldı	Достигната желаната светлост Dosaženo požadovaného jasu gewünschte Helligkeit erreicht Nået ønsket lysstyrke se alcanza la claridad deseada Soovitud heledus on saavutatud atteint la luminosité souhaitée Haluttu kirkkaus on saavutettu desired brightness attained Επιτεύχθηκε επιθυμητή φωτεινότητα A kívánt világosság elérve Željena svjetloća je postignuta Raggiunge la luminosità desiderata Pasiektas norimas šviesumas Sasniegta nepieciešamā spilgtuma pakāpe Lyset begynner å dimme Gewenste helderheid bereikt O brilho pretendido foi atingido Požadany poziom jasności zostat osiągnięty Luminozitate dorită atinsă желаемая яркость достигнута Onskad ljusstyrka uppnådd dosiahnutý požadovaný jas dosežena želena svetlost postignuta željena osvetljenost Istenilen aydınliğa ulaşıldı	Лампата започва да регулира светлинния поток Světlo se začne ztlumovat Leuchte beginnt zu dimmen Lampen begynder at aftage i styrke La lámpara comienza a regular Valgus hakkab häänduma La lumière commence à baisser Valo alkaa himmentymään light starts to dim Το φως φηχίζει να εξασθενεί A lámpa fénye tompulni kezd Svetlo se počinje prigušivati La luminosità inizia a ridursi Šviesos pritemsta Lampa sāk samazināt spilgtumu Lyset begynner å dimme Lamp begint te dimmen A lámpada começa a regular a intensidade da luz Lampa zaczyna ściemniać się Lampa începe să reducă lumina светильник плавно набирает яркость Lampan börjar att dimra svetidlo sa začne stmievať Svetilka prične zatemnjevat svetiljka počinje da zatamnjuje Aydınlatma, kararmaya başlar

I	I
	
Светлостта запаметена Jas uložen Helligkeit gespeichert Lysstyrke gemt La claridad se almacena Heledus on salvestatud Luminosité mise en mémoire Kirkkaus on tallennettu brightness level saved Εξοικονόμηση φωτεινότητας Világosság tárolva Pohranjena svetloća Luminositā salvata Šviesumas išsaugotas Spilgtuma pakāpe saglabāta Lyset begynner å dimme Helderheid opgeslagen Brilho está memorizado Zapisano poziom jasności Luminozitate memorată яркость сохранена Ljusstyrkan sparades jas uloženy svetlost shranjena osvetljenost je memorisana Aydınlik kaydedildi	Достигната желаната светлост Dosaženo požadovaného jasu gewünschte Helligkeit erreicht Nået ønsket lysstyrke se alcanza la claridad deseada Soovitud heledus on saavutatud atteint la luminosité souhaitée Haluttu kirkkaus on saavutettu desired brightness attained Επιτεύχθηκε επιθυμητή φωτεινότητα A kívánt világosság elérve Željena svjetloća je postignuta Raggiunge la luminosità desiderata Pasiektas norimas šviesumas Sasniegta nepieciešamā spilgtuma pakāpe Lyset begynner å dimme Gewenste helderheid bereikt O brilho pretendido foi atingido Požadany poziom jasności zostat osiągnięty Luminozitate dorită atinsă желаемая яркость достигнута Onskad ljusstyrka uppnådd dosiahnutý požadovaný jas dosežena želena svetlost postignuta željena osvetljenost Istenilen aydınliğa ulaşıldı