



SMART
HOME
LIGHTS

D | Montageanleitung · GB | Fitting instructions

832469

230V / 50Hz~
2x 18W LED-Board
nicht wechselbar / not changeable

 2,4 GHz
10 dBm

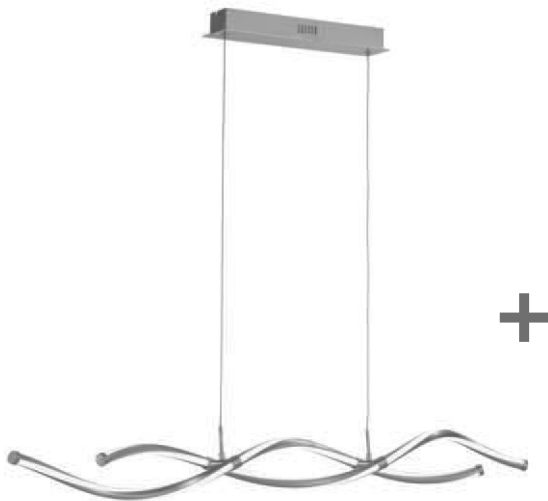

AAA, 1,5V

inkl. Funkfernbedienung
incl. radio remote control



18 W
2.250 lm



47 W
1.650 lm



LED-Board



t 25.000 h



T_k 2.700-5.000 K



15.000 x



<0,5 s



dimmmable with rrc



1 | Montage / fitting

als Pendelleuchte
as pendant light

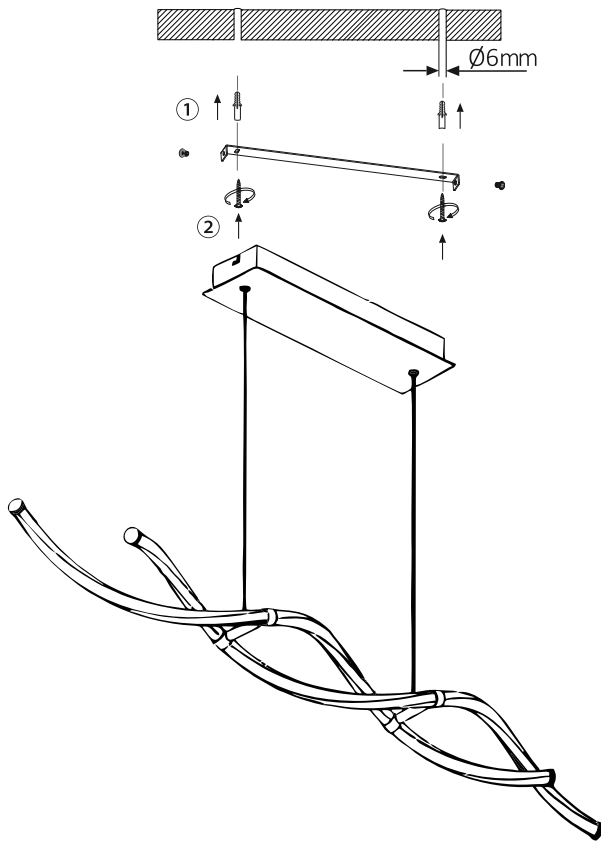

2 | Elektrischer Anschluss / electrical connection

230 Volt / 50Hz-Anschluss

230 voltage / 50Hz connection

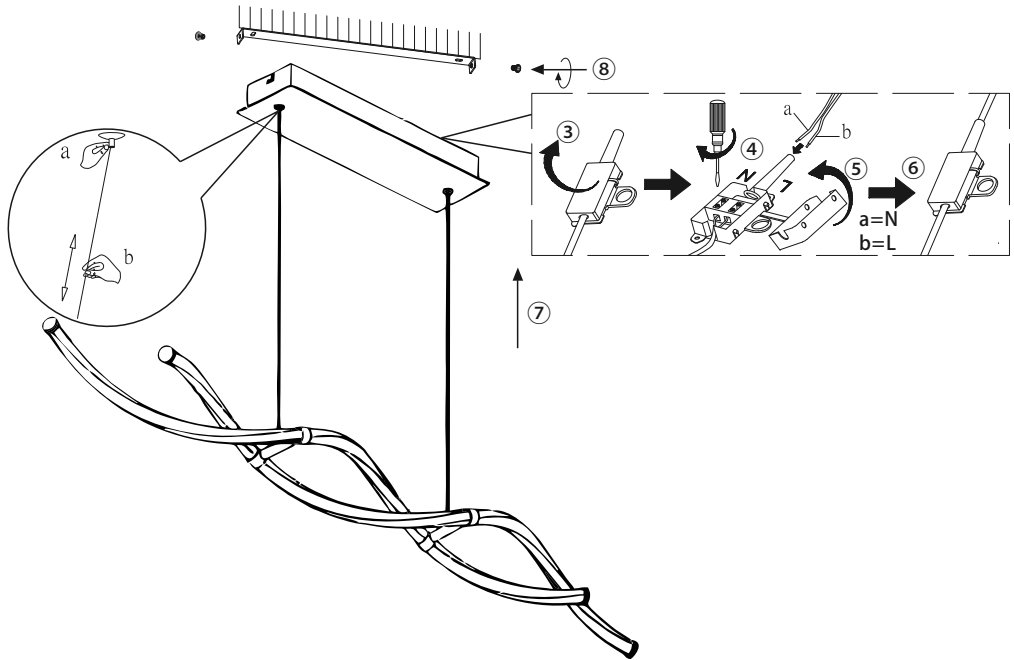

3 | Fernbedienung anlernen / teach remote control

Siehe Q-Fernbedienungsanleitung
See Q-remote control manual

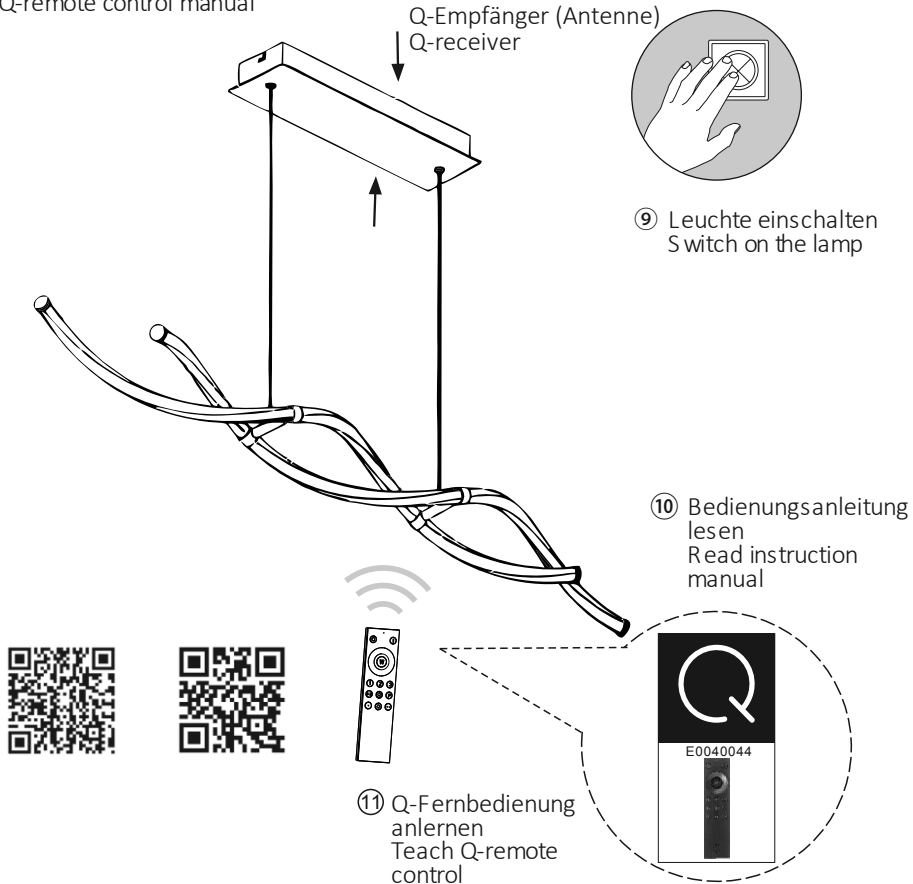

Reset

Rückstellen der Leuchte auf Werkseinstellung
Reset the lamp, factory new

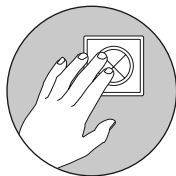

5 x on/off

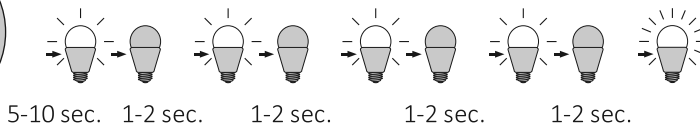

Das Gerät erfüllt die grundlegenden Anforderungen der Richtlinie 2014/53/EU (Radio Equipment Directive) des Europäischen Parlaments und des Rates der europäischen Union vom 16.04.2014 über Funkanlagen. Die vollständige Konformitätserklärung kann bei der unten stehenden Internet-Adresse aufgerufen werden.

This device fulfils the fundamental requirements of Directive 2014/53/EU (Radio Equipment Directive) of the European Parliament and of the Council of the European Union dated 16.04.2014 on items of radio equipment.

The full declaration of conformity can be accessed at the Internet-address given below.

Paul Neuhaus

Paul Neuhaus GmbH
Olakenweg 36 · 59457 Werl
Germany
Telefon: +49(0) 2922-9721-0
Telefax: +49(0) 2922-9721-9120
E-Mail: Kundenservice@neuhaus.group.de
<https://scm.paul-neuhaus.de/public/conformity/>