

# LeuchtenDirekt

LeuchtenDirekt GmbH

Olakenweg 36 · D-59457 Werl

+49(0)2922 9721 9290

Kundenservice@neuhaus-group.de

www.leuchtdirekt.de

# LeuchtenDirekt



997509 - KELLY

DE  
GB  
FR  
BG  
CZ  
DK  
EL  
ES  
ET  
FI  
HR  
HU  
IT  
LT  
LV  
NL  
NO  
PL  
PT  
RO  
RU  
SK  
SL  
SR  
SV  
TR

- DE** Dieses Produkt enthält eine Lichtquelle der Energieeffizienzklasse <D>.
- GB** This product contains a light source of energy efficiency class <D>.
- FR** Ce produit comprend une source de lumière de classe d'efficacité énergétique <D>.
- BG** Продуктът съдържа източник на светлина с клас на енергийна ефективност <D>.
- CZ** Tento výrobek obsahuje světelný zdroj třídy energetické účinnosti <D>.
- DK** Dette produkt indeholder en lyskilde af energieeffektklasse <D>.
- EL** Tento výrobek obsahuje světelný zdroj třídy energetické účinnosti <D>.
- ES** Este producto contiene una fuente de luz de la clase de eficiencia energética <D>.
- ET** See toode sisaldab valgusallikat energiatõhusklassiga <D>.
- FI** Tämä tuote sisältää energiatehokkuusluokan <D> valonlähteen.
- HR** Ovaj proizvod sadrži izvor svjetlosti energetskog razreda <D>.
- HU** Ez a termék <D> energiahatókonysági osztályba tartozó fényforrást tartalmaz.
- IT** Questo prodotto contiene una sorgente luminosa della classe di efficienza energetica <D>.
- LT** Šis produktas yra su šviesos šaltiniu, kurio energinio efektyvumo klasė yra <D>.
- LV** Šis izstrādājums satur gaismas avotu, kas atbilst energoefektivitātes klasei <D>.
- NL** Dit product bevat een lichtbron van energie-efficiëntieklasse <D>.
- NO** Dette produktet inneholder en lyskilde i energieffektivitetsklasse <D>.
- PL** Produkt ten zawiera źródło światła o klasie efektywności energetycznej <D>.
- PT** Este produto contém uma fonte de luz da classe de eficiência energética <D>.
- RO** Acest produs conține o sursă de lumină din clasa de eficiență energetică <D>.
- RU** Данное изделие содержит источник света класса энергоэффективности <D>.
- SK** Tento výrobek obsahuje zdroj svetla triedy energetickej efektivity <D>.
- SL** Ta izdelek vsebuje svetlobni vir razreda energijske učinkovitosti <D>.
- SR** Ovaj proizvod sadrži izvor svetlosti energetske klase <D>.
- SV** Denna produkt innehåller en ljuskälla i energieffektivitetsklass <D>.
- TR** Bu ürün, enerji verimliliği sınıfına sahip bir ışık kaynağı içerir <D>.

LED 7 W  
1.180 lm  
10 W  
800 lm  
t 30.000 h  
T<sub>K</sub> 3.000 - 6.000 K  
15.000 x  
< 0,5 s

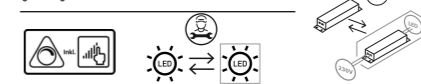

997509







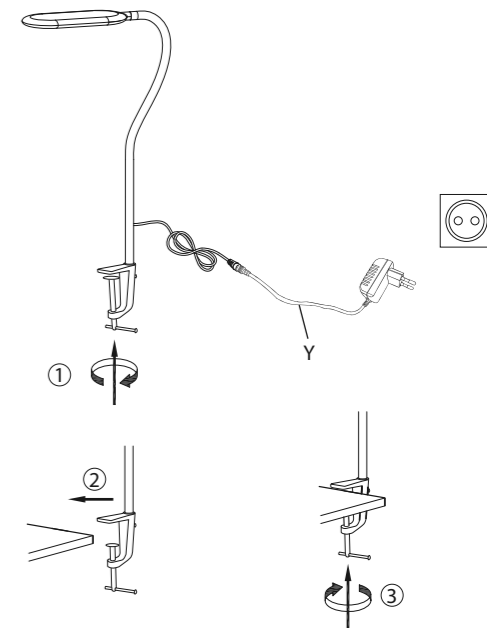

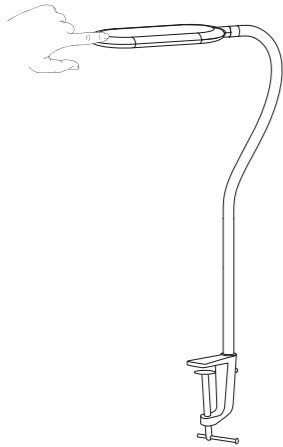
230V / 50Hz~

LED 1 x LED-Board 8,7V DC / 7 W

1x





|   |  |  |  |
|---|--|--|--|
| <b>M</b>  | <br>3.000 K | <br>4.000 K | <br>6.000 K |
| <br><b>⏻</b> | <br>0       | <br>I       |  |
| <b>+ -</b>  | <br>10%     | <br>50%     | <br>100%    |