

ideal lux®

IDEAL LUX s.r.l.
Via Taglio Destro 32
30035 Mirano (VE) Italy
www.ideal-lux.com

IDEAL LUX Warehouse
Via delle Industrie, 8/D
30036 Santa Maria di Sala (Venezia)
8.00 - 12.00 / 13.30 - 17.00

ideal lux®



REV 02/08/2021

Holiday AP2

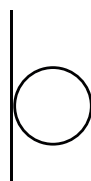

Lampada da parete
Wall lamp
Applique
Wandleuchte
Lámpara de pared
Настенные светильники



LED

max 1 x 40W E14 + 1W LED /
220~240V 50/60Hz
- 8021696124162 BIANCO
- 8021696124179 NERO

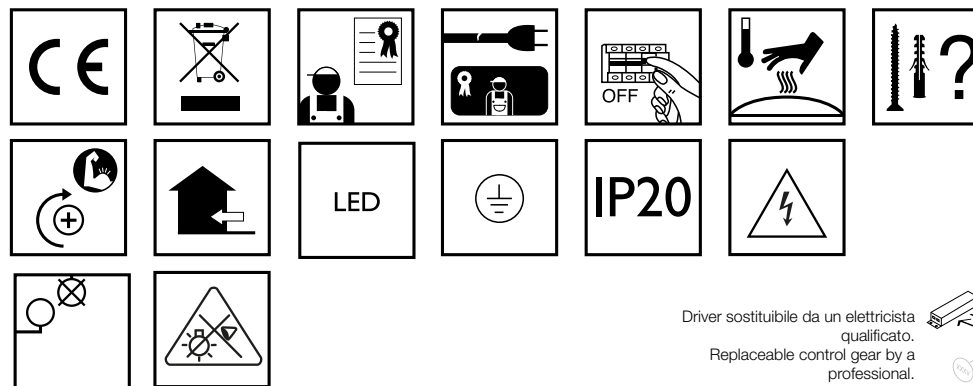
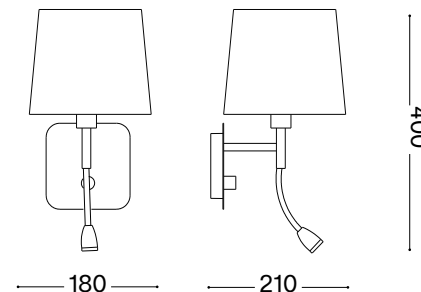

Questo prodotto è fornito con una sorgente luminosa di classe energetica /
This product is provided with a light source with energy class of:
G

Driver sostituibile da un elettricista qualificato.
Replaceable control gear by a professional.

Fonte luminosa sostituibile da un elettricista qualificato.
Replaceable light-source by a professional.

IDEAL LUX s.r.l.
Via Taglio Destro 32
30035 Mirano (VE) Italy
www.ideal-lux.com

IDEAL LUX Warehouse
Via delle Industrie, 8/D
30036 Santa Maria di Sala (Venezia)
8.00 - 12.00 / 13.30 - 17.00

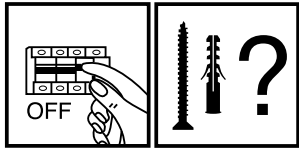

1

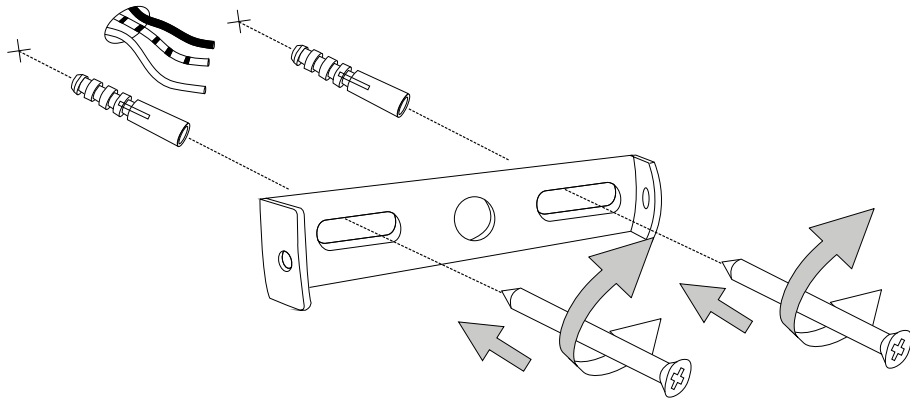

2

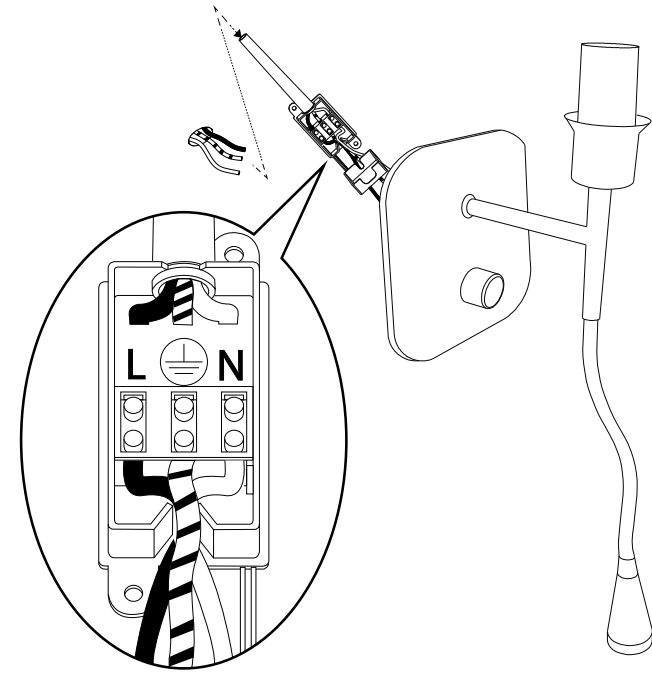

3

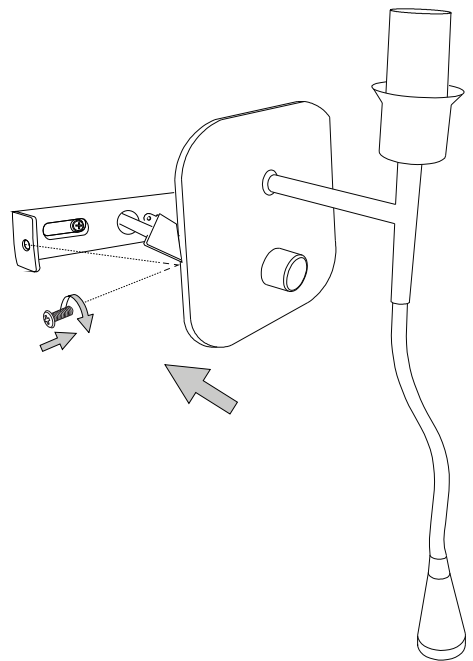

4

